





KOA Sanitary Fittings

BY KURIYAMA







Index



SANITARY TRI-CLAMP FITTINGS

	TCS-SS	112
	BHAS-SS.....	113
	RHAS-SS.....	114



SANITARY TRI-CLAMP ADAPTER FITTINGS

	TCMPS-SS	115
	TCFPS-SS	116
	TCWL-SS.....	117
	TCWS-SS	118



SANITARY CLAMPS

	SPHDS	119
	DPHDS	119
	DBS.....	119

SANITARY BEVEL SEAT FITTINGS

	FBS-SS	120
	MBS-SS	120
	HNS.....	124





SANITARY I-LINE FITTINGS

	FILS-SS.....	121
	MILS-SS.....	121
	SPILC	123

SANITARY TUBE ENDS

	TES-SS	122
---	--------------	-----

SANITARY ACCESSORIES

	SSHW.....	123
	TSHW.....	123
	TCSC-SS	124
	SHB.....	125
	SHR.....	125

SANITARY FERRULES

	SCF-SS	126-127
---	--------------	---------



KURICRIMP™ FERRULES

	CRF-SS	128
---	--------------	-----



Because we continually examine ways to improve our products, we reserve the right to alter specifications or discontinue products without prior notice.

Index (continued)

TRI-CLAMP GASKETS

	Sanitary Buna-N Tri-Clamp Gasket Black 129
	Sanitary Buna-N Tri-Clamp Gasket White 129
	Sanitary EPDM Tri-Clamp Gasket Black 130
	Sanitary FKM Tri-Clamp Gasket Black 130
	Sanitary FKM Tri-Clamp Gasket White 130
	Sanitary PTFE Tri-Clamp Gasket White 131
	Sanitary Silicone Tri-Clamp Gasket White 131

I-LINE GASKETS

	Sanitary Buna-N I-Line Gasket Black.... 132
	Sanitary FKM I-Line Gasket Black..... 132

BEVEL SEAT GASKETS

	Sanitary Buna-N Bevel Seat Gasket Black 133
---	--

BUMPERS AND RISERS	138
---------------------------------	-----

FITTING INFORMATION	110-111
----------------------------------	---------

QUALITY ASSURANCE	109
--------------------------------	-----

SANITARY CLAMP TYPES	134
-----------------------------------	-----

SIZING GUIDE	135
---------------------------	-----

SANITARY GASKET TYPES	136
------------------------------------	-----

SANITARY GASKET IDENTIFICATION	137
---	-----

Because we continually examine ways to improve our products, we reserve the right to alter specifications or discontinue products without prior notice.

A SYMBOL OF QUALITY

Every KOA Sanitary Hose Fitting is compliant with the 3-A Sanitary Standard for Sanitary Fittings and certified to the 3-A RPSCQC 62-02 Standard for Hose Assemblies.



Every KOA Sanitary Hose Fitting is compliant with the 3-A Sanitary Standard for Sanitary Fittings and certified 3-A RPSCQC 62-02 for Standard Hose Assemblies.



Every KOA Sanitary Rubber Gasket is certified to meet the 3-A Sanitary Standard for Multiple-Use Rubber Materials Used as Product Contact Surfaces.



Kuriyama is certified to provide complete sanitary hose assemblies compliant with the 3-A Sanitary Standard for Hose Assemblies.

THE KOA SANITARY ADVANTAGE

Material Safety – Every KOA Sanitary Fitting is made from 316L stainless steel, and can be traced back to its original Material Test Report (MTR) by the heat number imprinted on each individual fitting. Individual Material Test Reports are available upon request.

Food Safety – Sanitary fittings are manufactured with a smooth (32 Ra) polish on food contact surfaces, and without any pockets or tight radii where food could become trapped. Additionally, KOA Sanitary Fittings are designed with Finepoint™ barb ends, virtually eliminating areas where food or other transferred materials can become trapped at the fitting to hose transition area.

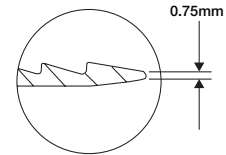

*Finepoint™
barb ends help
prevent food
entrapment*

Quality Control – In addition to the quality assurance inspections performed during manufacturing, KOA Sanitary Fittings are independently lab tested after their manufacture to ensure conformance of their physical properties using an Olympus Innov-X Alloys and Metals Analyzer.

Cleaning & Packaging – After manufacturing, KOA Sanitary Fittings undergo an ultrasonic cleaning process, and are individually bubble and shrink-wrapped to ensure they arrive in pristine condition.



Because we continually examine ways to improve our products, we reserve the right to alter specifications or discontinue products without prior notice.

SANITARY FITTING TYPES (CLAMPED)

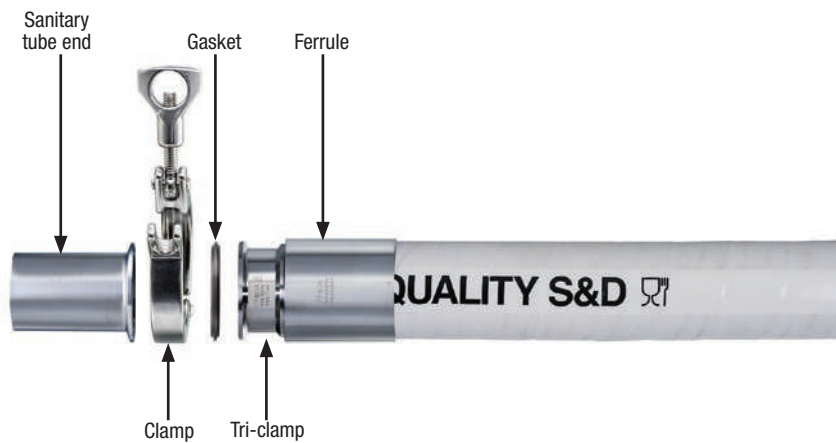

TRI-CLAMP

Tri-Clamp fittings are the industry standard. The connection consists of two identical, flat-faced flanges, connected by use of a clamp. A gasket is placed into the grooves on the faces to prevent leakage.

KOA Sanitary Fittings offers both crimpable Tri-Clamps for clean in place (CIP), and also clampable, rubber hose and brewery hose Tri-Clamp fittings, for clean out of place (COP) operations.

Note: Most Tri-Clamp fitting sizes match the size of their corresponding clamp. However, to increase clamp interchangeability (thereby reducing the variety of clamps which must be stocked) the 1 1/2" clamp is used with the 1" Tri-Clamp fitting. Please refer to the Tri-Clamp sizing chart on page 135 to determine the correct clamp required based on fitting size.

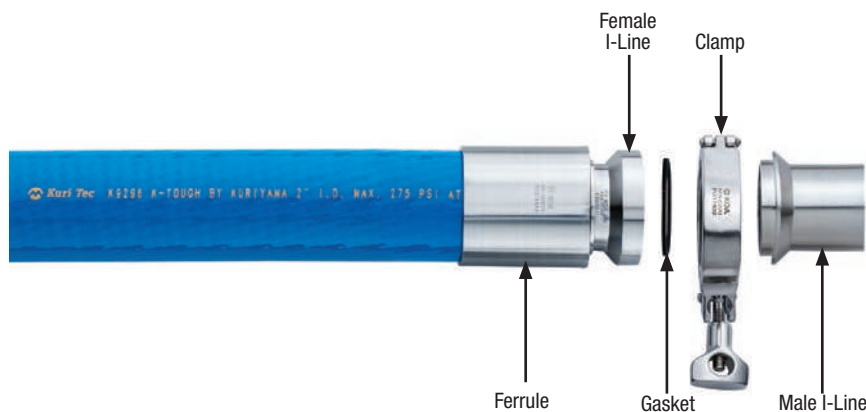

I-LINE

I-Line fittings are heavier duty for use in more demanding applications. The connection consists of male and female versions, nested together and secured with a gasket and clamp. They're able to withstand greater temperatures, vibrations and pressures than standard tri-clamp fittings. Also, the design helps eliminate over compression of the gasket. They're popular in the wine and tomato processing industries.

Because we continually examine ways to improve our products, we reserve the right to alter specifications or discontinue products without prior notice.

SANITARY FITTING TYPES (NON-CLAMPED)

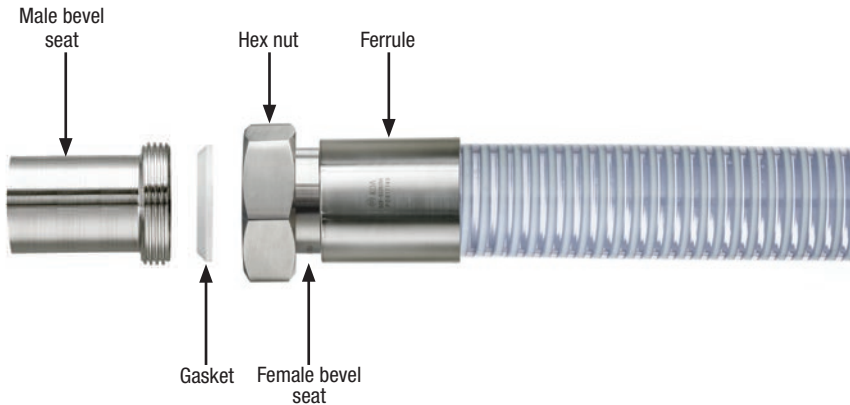

BEVEL SEAT

Bevel Seat fittings, also referred to as Acme threads, are generally used in lower pressure applications such as milk transfer. The connection consists of a male and a female end, the faces of which are angled 45° to create a metal on metal sealing surface. The male bevel seat is threaded, and the two are joined together by use of a nut. The metal on metal seal is sometimes considered sufficient to prevent leakage at lower pressures, however, a gasket can be used for higher pressure applications. Special Bevel Seat Hex Wrenches are available to assist with nut tightening and untightening.



TUBE END

Tube end fittings, also referred to as butt-weld fittings, are used for welding onto sanitary tube fittings. The connection consists of a schedule 40 tube end which is welded directly onto the sanitary tubing, giving the versatility to create any type of sanitary fitting hose end connection.

Because we continually examine ways to improve our products, we reserve the right to alter specifications or discontinue products without prior notice.

TCS-SS Series (316 Stainless Steel)

Sanitary Crimp Hose Fitting Tri-Clamp x Hose Shank



FEATURES AND ADVANTAGES

- Durable 316 stainless steel.
- Smooth 32 Ra food contact surface finish.
- Certified to 3-A RPSCQC 62-02 for sanitary assemblies.
- Designed for use with KOA sanitary and standard KuriCrimp Ferrules. (pgs 126-128)
- Uses SPHDS, DPHDS or DBS series clamps. (pg 119)
- Uses Tri-Clamp gaskets. (pgs 129-131)

VIEW ONLINE



SCAN FOR INFO
or visit

KOA.link/TCS-SS

Part Number	Size (in)	PSI Rating at 70°F	Weight Each (lbs)	Standard Carton
TCS-SS100	1	690	0.46	70
TCS-SS150	1 1/2	690	0.63	35
TCS-SS200	2	690	1.20	24
TCS-SS250	2 1/2	435	1.41	12
TCS-SS300	3	435	2.34	12
TCS-SS400	4	435	3.79	6

Because we continually examine ways to improve our products, we reserve the right to alter specifications or discontinue products without prior notice.



BHAS-SS Series (316 Stainless Steel)

Sanitary Brewery Hose Fitting
Tri-Clamp x Long Hose Shank



FEATURES AND ADVANTAGES

- Durable 316 stainless steel.
- Smooth 32 Ra food contact surface finish.
- Certified to 3-A RPSCQC 62-02 for sanitary assemblies.
- Uses SPHDS, DPHDS or DBS series clamps. (pg 119)
- Uses Tri-Clamp gaskets. (pgs 129-131)

VIEW ONLINE



SCAN FOR INFO
or visit
KOA.link/BHAS-SS

Part Number	Size (in)	PSI Rating at 70°F	Weight Each (lbs)	Standard Carton
BHAS-SS100	1	690	0.35	80
BHAS-SS125	1 1/4	690	0.49	18
BHAS-SS150	1 1/2	690	0.62	40
BHAS-SS200	2	690	0.86	24
BHAS-SS300	3	435	1.90	12
BHAS-SS400	4	435	3.00	6



FOR INFO ON THE
T422LH SERIES LIQUID S&D
BREWERY HOSE VISIT
TheBrewt.com

Because we continually examine ways to improve our products, we reserve the right to alter specifications or discontinue products without prior notice.



RHAS-SS Series (316 Stainless Steel)

Sanitary Hose Fitting

Tri-Clamp x Short Hose Shank

FEATURES AND ADVANTAGES

- Durable 316 stainless steel.
- Smooth 32 Ra food contact surface finish.
- Certified to 3-A RPSCQC 62-02 for sanitary assemblies.
- Uses SPHDS, DPHDS or DBS series clamps. (pg 119)
- Uses Tri-Clamp gaskets. (pgs 129-131)



VIEW ONLINE



SCAN FOR INFO

or visit

KOA.link/RHAS-SS

Part Number	Fitting End Size (in)	Hose Shank Size (in)	PSI Rating at 70°F	Weight Each (lbs)	Standard Carton
RHAS-SS100038	1	3/8	690	0.18	210
RHAS-SS100050	1	1/2	690	0.20	210
RHAS-SS100075	1	3/4	690	0.22	168
RHAS-SS100	1	1	690	0.24	168
RHAS-SS150050	1 1/2	1/2	690	0.18	210
RHAS-SS150062	1 1/2	5/8	690	0.22	210
RHAS-SS150075	1 1/2	3/4	690	0.18	210
RHAS-SS150100	1 1/2	1	690	0.22	168
RHAS-SS150	1 1/2	1 1/2	690	0.26	168
RHAS-SS200150	2	1 1/2	690	0.37	72
RHAS-SS200	2	2	690	0.40	96
RHAS-SS250	2 1/2	2 1/2	435	0.75	12
RHAS-SS300	3	3	435	1.12	24
RHAS-SS400	4	4	435	1.94	12
RHAS-SS600	6	6	435	3.25	6

Because we continually examine ways to improve our products, we reserve the right to alter specifications or discontinue products without prior notice.



TCMPS-SS Series (316 Stainless Steel)

Sanitary Adapter

Tri-Clamp x Male Pipe (NPT Threads)

FEATURES AND ADVANTAGES

- Durable 316 stainless steel.
- Smooth 32 Ra food contact surface finish.
- Uses SPHDS, DPHDS or DBS series clamps. (pg 119)
- Uses Tri-Clamp gaskets. (pgs 129-131)

VIEW ONLINE



SCAN FOR INFO

or visit

KOA.link/TCMPS-SS

Part Number	Fitting End Size (in)	NPT Size (in)	PSI Rating at 70°F	Weight Each (lbs)	Standard Carton
TCMPS-SS100075	1	3/4	690	0.55	144
TCMPS-SS100	1	1	690	0.90	144
TCMPS-SS150	1 1/2	1 1/2	690	1.44	144
TCMPS-SS150200	1 1/2	2	690	2.48	144
TCMPS-SS200150	2	1 1/2	690	2.15	72
TCMPS-SS200	2	2	690	3.12	72
TCMPS-SS250200	2 1/2	2	435	2.60	48
TCMPS-SS250	2 1/2	2 1/2	435	2.76	48
TCMPS-SS300200	3	2	435	3.36	12
TCMPS-SS300	3	3	435	5.00	12
TCMPS-SS400	4	4	435	6.95	12

Because we continually examine ways to improve our products, we reserve the right to alter specifications or discontinue products without prior notice.



TCFPS-SS Series (316 Stainless Steel)

Sanitary Adapter

Tri-Clamp x Female Pipe (NPT Threads)

FEATURES AND ADVANTAGES

- Durable 316 stainless steel.
- Smooth 32 Ra food contact surface finish.
- Uses SPHDS, DPHDS or DBS series clamps. (pg 119)
- Uses Tri-Clamp gaskets. (pgs 129-131)

VIEW ONLINE



SCAN FOR INFO
or visit
KOA.link/TCFPS-SS

Part Number	Fitting End Size (in)	NPT Size (in)	PSI Rating at 70°F	Weight Each (lbs)	Standard Carton
TCFPS-SS100075	1	3/4	690	0.46	144
TCFPS-SS100	1	1	690	0.69	144
TCFPS-SS150	1 1/2	1 1/2	690	1.39	144
TCFPS-SS150200	1 1/2	2	690	2.52	144
TCFPS-SS200150	2	1 1/2	690	1.21	144
TCFPS-SS200	2	2	690	1.91	72
TCFPS-SS250200	2 1/2	2	435	1.66	72
TCFPS-SS250	2 1/2	2 1/2	435	1.91	72
TCFPS-SS300200	3	2	435	2.91	12
TCFPS-SS300	3	3	435	3.02	12
TCFPS-SS400	4	4	435	5.72	12

Because we continually examine ways to improve our products, we reserve the right to alter specifications or discontinue products without prior notice.



TCWL-SS Series (316 Stainless Steel)
Sanitary Adapter
Tri-Clamp x Weld On (Long)



FEATURES AND ADVANTAGES

- Durable 316 stainless steel.
- Smooth 32 Ra food contact surface finish.
- Meets 3-A 63-04 sanitary standard for sanitary fittings.
- Uses SPHDS, DPHDS or DBS series clamps. (pg 119)
- Uses Tri-Clamp gaskets. (pgs 129-131)

VIEW ONLINE



SCAN FOR INFO
or visit
KOA.link/TCWL-SS

Part Number	Size (in)	PSI Rating at 70°F	Weight Each (lbs)	Standard Carton
TCWL-SS050	1/2	690	0.05	480
TCWL-SS075	3/4	690	0.06	480
TCWL-SS100	1	690	0.19	240
TCWL-SS150	1 1/2	690	0.15	240
TCWL-SS200	2	690	0.21	192
TCWL-SS250	2 1/2	435	0.27	144
TCWL-SS300	3	435	0.34	144
TCWL-SS400	4	435	0.71	72
TCWL-SS600	6	435	1.15	36

Because we continually examine ways to improve our products, we reserve the right to alter specifications or discontinue products without prior notice.

TCWS-SS Series (316 Stainless Steel)

Sanitary Adapter

Tri-Clamp x Weld On (Short)



FEATURES AND ADVANTAGES

- Durable 316 stainless steel.
- Smooth 32 Ra food contact surface finish.
- Meets 3-A 63-04 sanitary standard for sanitary fittings.
- Uses SPHDS, DPHDS or DBS series clamps. (pg 119)
- Uses Tri-Clamp gaskets. (pgs 129-131)

VIEW ONLINE



SCAN FOR INFO
or visit
KOA.link/TCWS-SS

Part Number	Size (in)	PSI Rating at 70°F	Weight Each (lbs)	Standard Carton
TCWS-SS050	1/2	690	0.04	480
TCWS-SS075	3/4	690	0.04	480
TCWS-SS100	1	690	0.16	240
TCWS-SS150	1 1/2	690	0.10	240
TCWS-SS200	2	690	0.14	192
TCWS-SS250	2 1/2	435	0.18	144
TCWS-SS300	3	435	0.23	144
TCWS-SS400	4	435	0.41	72
TCWS-SS600	6	435	0.71	36

Because we continually examine ways to improve our products, we reserve the right to alter specifications or discontinue products without prior notice.

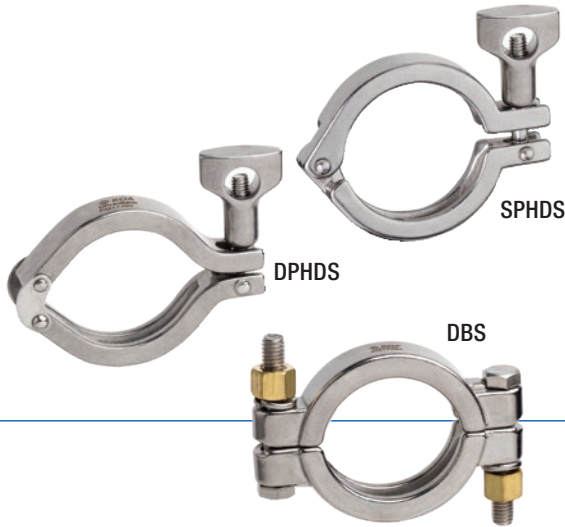

SPHDS Series (304 Stainless Steel)
Sanitary Single Pin Clamp

DPHDS Series (304 Stainless Steel)
Sanitary Double Pin Clamp

DBS Series (304 Stainless Steel)
Sanitary Bolted Clamp

VIEW ONLINE



SCAN FOR INFO
or visit

KOA.link/Sanitary-Clamps

FEATURES AND ADVANTAGES

- Durable 304 stainless steel.
- For use with TCS-SS, RHAS-SS or BHAS-SS series fittings.
- For use with adapters TCMPSS-SS, TCFPS-SS, TCWL-SS, TCWS-SS.
- **DPHDS** – Double pin design for more even sealing pressure.
- **DBS** – Double bolt design for higher pressures.

Part Number	Fitting End Size (in)	Clamp Size (in)	Weight Each (lbs)	Standard Carton
SPHDS150	1 & 1 1/2	1 1/2	0.37	100
SPHDS200	2	2	0.60	80
SPHDS250	2 1/2	2 1/2	0.68	12
SPHDS300	3	3	0.77	50
SPHDS400	4	4	0.94	40
SPHDS600	6	6	18.7	6
DPHDS150	1 & 1 1/2	1 1/2	0.51	50
DPHDS200	2	2	0.60	40
DPHDS250	2 1/2	2 1/2	0.64	12
DPHDS300	3	3	0.74	20
DPHDS400	4	4	1.02	20
DBS150	1 & 1 1/2	1 1/2	0.55	40
DBS200	2	2	0.95	40
DBS300	3	3	1.21	30
DBS400	4	4	1.81	25

Because we continually examine ways to improve our products, we reserve the right to alter specifications or discontinue products without prior notice.



MBS-SS



FBS-SS

FBS-SS Series (316 Stainless Steel)

Sanitary Crimp Hose Fitting

Female Bevel Seat x Hose Shank

MBS-SS Series (316 Stainless Steel)

Sanitary Crimp Hose Fitting

Male Bevel Seat x Hose Shank

FEATURES AND ADVANTAGES

- Durable 316 stainless steel.
- Smooth 32 Ra food contact surface finish.
- Certified to 3-A RPSCQC 62-02 for sanitary assemblies.
- Designed for use with KOA sanitary and standard KuriCrimp Ferrules. (pgs 126-128)
- Uses Bevel Seat gaskets. (pg 133)
- **FBS-SS** – Uses HNS series hex nuts. (pg 124)

VIEW ONLINE



SCAN FOR INFO

or visit

KOA.link/Bevel-Seat

Part Number	Size (in)	PSI Rating at 70°F	Weight Each (lbs)	Standard Carton
FBS-SS100	1	690	0.33	108
FBS-SS150	1 1/2	690	0.60	48
FBS-SS200	2	690	0.95	48
FBS-SS250	2 1/2	435	1.43	12
FBS-SS300	3	435	2.38	12
FBS-SS400	4	435	3.95	6
MBS-SS100	1	690	0.55	200
MBS-SS150	1 1/2	690	0.97	200
MBS-SS200	2	690	1.81	200
MBS-SS250	2 1/2	435	2.28	100
MBS-SS300	3	435	3.58	100
MBS-SS400	4	435	5.92	100

Because we continually examine ways to improve our products, we reserve the right to alter specifications or discontinue products without prior notice.



FILS-SS Series (316 Stainless Steel)

Sanitary Crimp Hose Fitting
Female I-Line x Hose Shank

MILS-SS Series (316 Stainless Steel)

Sanitary Crimp Hose Fitting
Male I-Line x Hose Shank

FEATURES AND ADVANTAGES

- Durable 316 stainless steel.
- Smooth 32 Ra food contact surface finish.
- Certified to 3-A RPSCQC 62-02 for sanitary assemblies.
- Designed for use with KOA sanitary and standard KuriCrimp Ferrules. (pgs 126-128)
- Uses SPILC series clamps. (pg 123)
- Uses I-Line gaskets. (pg 132)

VIEW ONLINE



SCAN FOR INFO
or visit
KOA.link/I-Line

Part Number	Size (in)	PSI Rating at 70°F	Weight Each (lbs)	Standard Carton
FILS-SS150	1 1/2	690	1.01	35
FILS-SS200	2	690	1.21	40
FILS-SS300	3	435	2.62	12
FILS-SS400	4	435	4.17	6
MILS-SS150	1 1/2	690	0.77	72
MILS-SS200	2	690	1.55	24
MILS-SS300	3	435	3.36	12
MILS-SS400	4	435	5.15	6

Because we continually examine ways to improve our products, we reserve the right to alter specifications or discontinue products without prior notice.



TES-SS Series (316 Stainless Steel)

Sanitary Crimp Hose Fitting

Tube End x Hose Shank

FEATURES AND ADVANTAGES

- Schedule 40 pipe size.
- Durable 316 stainless steel.
- Smooth 32 Ra food contact surface finish.
- Certified to 3-A RPSCQC 62-02 for sanitary assemblies.
- Designed for use with KOA sanitary and standard KuriCrimp Ferrules. (pgs 126-128)
- Welds onto sanitary weld fittings or tubing.

VIEW ONLINE



SCAN FOR INFO

or visit

KOA.link/TES-SS

Part Number	Size (in)	PSI Rating at 70°F	Weight Each (lbs)	Standard Carton
TES-SS150	1 1/2	690	0.53	48
TES-SS200	2	690	0.75	35
TES-SS300	3	435	2.09	12
TES-SS400	4	435	3.46	7

Because we continually examine ways to improve our products, we reserve the right to alter specifications or discontinue products without prior notice.

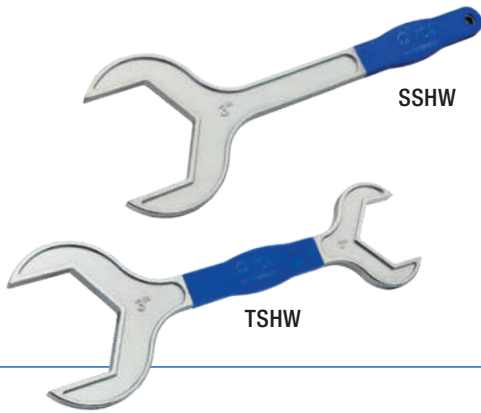

SSHW Series
Sanitary Single Side Hex Wrench
(for Bevel Seat Hex Nut)

TSHW Series
Sanitary Double Side Hex Wrench
(for Bevel Seat Hex Nut)

VIEW ONLINE



SCAN FOR INFO

or visit

KOA.link/Sanitary-Wrench

FEATURES AND ADVANTAGES

- Durable plated carbon steel.
- Soft-touch, food grade, silicone handle.
- For use with HNS Series hex nut.

Part Number	Size (in)	Weight Each (lbs)	Standard Carton
SSHW100	1	0.60	1
SSHW150	1 1/2	0.82	1
SSHW200	2	1.52	1
SSHW250	2 1/2	2.14	1
SSHW300	3	3.13	1
SSHW400	4	3.73	1
TSHW100150	1 X 1 1/2	1.08	1
TSHW200300	2 x 3	3.48	1



SPILC Series (304 Stainless Steel)
Sanitary Single Pin Clamp (for I-line)

FEATURES AND ADVANTAGES

- Durable 304 stainless steel.
- For use with FILS and MILS series fittings.

VIEW ONLINE



SCAN FOR INFO

or visit

KOA.link/SPILC

Part Number	Size (in)	Weight Each (lbs)	Standard Carton
SPILC150	1 1/2	0.64	48
SPILC200	2	0.77	36
SPILC300	3	1.34	12
SPILC400	4	1.74	12

Because we continually examine ways to improve our products, we reserve the right to alter specifications or discontinue products without prior notice.

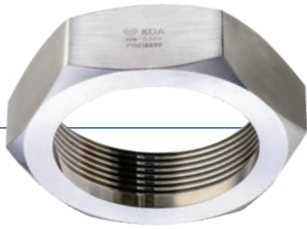

HNS Series (304 Stainless Steel)

Sanitary Hex Nuts (for Female Bevel Seat)

FEATURES AND ADVANTAGES

- Durable 304 stainless steel.
- Acme 8TPI thread (1" – 3"), Acme 6TPI thread (4").
- For use with FBS-SS series fittings.

VIEW ONLINE



SCAN FOR INFO
or visit

KOA.link/Bevel-HNS

Part Number	Size (in)	Weight Each (lbs)	Standard Carton
HNS100	1	0.33	144
HNS150	1 1/2	0.57	72
HNS200	2	0.84	60
HNS250	2 1/2	1.22	12
HNS300	3	1.96	18
HNS400	4	3.70	12



TCSC-SS Series (316 Stainless Steel)

Sanitary Tri-clamp End Cap

FEATURES AND ADVANTAGES

- Durable 316 stainless steel.
- Smooth 32 Ra food contact surface finish.
- Meets 3A 63-04 sanitary standard for sanitary fittings.
- For use with TCS-SS, RHAS-SS or BHAS-SS series fittings. For use with adapters TCMPS-SS, TCFPS-SS, TCWL-SS, TCWS-SS.

VIEW ONLINE



SCAN FOR INFO
or visit

KOA.link/TCSC-SS

Part Number	Fitting End Size (in)	Cap End Size (in)	Weight Each (lbs)	Standard Carton
TCSC-SS100150	1 & 1 1/2	1 1/2	0.17	250
TCSC-SS200	2	2	0.30	144
TCSC-SS250	2 1/2	2 1/2	0.44	60
TCSC-SS300	3	3	0.64	60
TCSC-SS400	4	4	1.32	36

Because we continually examine ways to improve our products, we reserve the right to alter specifications or discontinue products without prior notice.



SHB Series

Sanitary Hose Bumpers

SHR Series

Sanitary Hose Risers

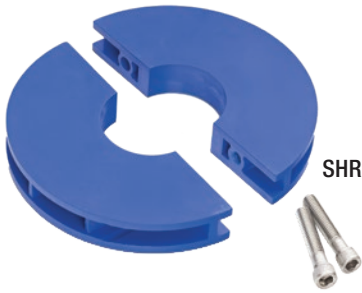

FEATURES AND ADVANTAGES (SHB)

- Slides easily and securely over crimp ferrules.
- Helps protect fittings from damage if dropped.
- Durable, heat resistant, non-marking silicone.
- Meets FDA CFR 21.

FEATURES AND ADVANTAGES (SHR)

- Helps protect hose cover from abrasion.
- Allows for easier hose dragging.
- Easily attached by two stainless steel screws.
- Durable, heat resistant polyethylene.
- Meets FDA CFR 21.

VIEW ONLINE



SCAN FOR INFO
or visit
KOA.link/SHB-SHR



Part Number	Size (in)	ID (in)	OD (in)	Standard Carton
SHB150	1 1/2	2.00	3.00	20
SHB200	2	2.58	3.55	16
SHB250	2 1/2	3.10	4.25	16
SHB300	3	3.60	4.72	16

Part Number	Size (in)	OD (in)	Fit Hose (in)	Standard Carton
SHR150	1 1/2	6.50	1.80 - 2.15	10
SHR150200	1 1/2 & 2	6.50	2.10 - 2.35	10
SHR200	2	7.00	2.39 - 2.69	10
SHR200300	2 & 3	8.00	3.30 - 3.75	10
SHR250	2 1/2	7.00	2.65 - 2.90	10
SHR400	4	8.00	4.55 - 5.31	10

Because we continually examine ways to improve our products, we reserve the right to alter specifications or discontinue products without prior notice.



SCF-SS Series (304 Stainless Steel) Sanitary Crimp Ferrules

FEATURES AND ADVANTAGES

- Smooth 64RA surface finish.
- Designed for use with TCS-SS, FBS-SS, MBS-SS, FILS-SS, MILS-SS and TES-SS series fittings.

VIEW ONLINE



SCAN FOR INFO
or visit

KOA.link/SCF-SS

Part Number	Hose ID	Ferrule ID		Wall Thickness		Length		Weight Each (lbs)	Standard Carton
	(in)	(in)	(mm)	(in)	(mm)	(in)	(mm)		
SCF-SS10138	1	1.38	35.0	0.108	2.7	2.28	57.9	0.28	126
SCF-SS10146	1	1.46	37.1	0.108	2.7	2.28	57.9	0.29	126
SCF-SS10153	1	1.53	38.9	0.108	2.7	2.28	57.9	0.31	144
SCF-SS10157	1	1.57	39.9	0.108	2.7	2.28	57.9	0.33	144
SCF-SS10161	1	1.61	40.9	0.108	2.7	2.28	57.9	0.35	144
SCF-SS10165	1	1.65	41.9	0.108	2.7	2.28	57.9	0.36	144
SCF-SS10173	1	1.73	43.9	0.108	2.7	2.28	57.9	0.37	96
SCF-SS15201	1 1/2	2.01	51.1	0.118	3.0	2.36	60.0	0.46	105
SCF-SS15206	1 1/2	2.06	52.3	0.118	3.0	2.36	60.0	0.49	90
SCF-SS15210	1 1/2	2.10	53.3	0.118	3.0	2.36	60.0	0.49	90
SCF-SS15215	1 1/2	2.15	54.6	0.118	3.0	2.36	60.0	0.51	72
SCF-SS15220	1 1/2	2.20	55.9	0.118	3.0	2.36	60.0	0.53	72
SCF-SS15228	1 1/2	2.28	57.9	0.118	3.0	2.36	60.0	0.55	72
SCF-SS15236	1 1/2	2.36	59.9	0.118	3.0	2.36	60.0	0.60	72
SCF-SS20248	2	2.48	63.0	0.128	3.3	2.80	71.1	0.68	60
SCF-SS20256	2	2.56	65.0	0.128	3.3	2.80	71.1	0.68	60
SCF-SS20264	2	2.64	67.1	0.128	3.3	2.80	71.1	0.73	60
SCF-SS20268	2	2.68	68.1	0.128	3.3	2.80	71.1	0.75	60
SCF-SS20273	2	2.73	69.3	0.128	3.3	2.80	71.1	0.77	45
SCF-SS20279	2	2.79	70.1	0.128	3.3	2.80	71.1	0.80	45
SCF-SS20287	2	2.87	72.9	0.128	3.3	2.80	71.1	0.84	45
SCF-SS20295	2	2.95	74.9	0.128	3.3	2.80	71.1	0.88	36
SCF-SS25300	2 1/2	3.00	76.2	0.138	3.5	3.25	82.6	0.95	12
SCF-SS25307	2 1/2	3.07	78.0	0.138	3.5	3.25	82.6	0.98	12
SCF-SS25315	2 1/2	3.15	80.0	0.138	3.5	3.25	82.6	1.02	12
SCF-SS25323	2 1/2	3.23	82.0	0.138	3.5	3.25	82.6	1.06	12
SCF-SS25331	2 1/2	3.31	84.1	0.138	3.5	3.25	82.6	1.10	12
SCF-SS25339	2 1/2	3.39	86.1	0.138	3.5	3.25	82.6	1.14	12
SCF-SS25346	2 1/2	3.46	87.9	0.138	3.5	3.25	82.6	1.18	12
SCF-SS30354	3	3.54	89.9	0.138	3.5	3.94	100.1	1.23	24
SCF-SS30360	3	3.60	91.4	0.138	3.5	3.94	100.1	1.30	24

(CONTINUED)

Because we continually examine ways to improve our products, we reserve the right to alter specifications or discontinue products without prior notice.



SCF-SS Series (304 Stainless Steel)
Sanitary Crimp Ferrules

FEATURES AND ADVANTAGES

- Smooth 64RA surface finish.
- Designed for use with TCS-SS, FBS-SS, MBS-SS, FILS-SS, MILS-SS and TES-SS series fittings.

VIEW ONLINE



SCAN FOR INFO

or visit

KOA.link/SCF-SS

(CONTINUED FROM PG. 125)

Part Number	Hose ID		Ferrule ID		Wall Thickness		Length		Weight Each (lbs)	Standard Carton
	(in)	(in)	(mm)	(in)	(mm)	(in)	(mm)			
SCF-SS30368	3	3.68	93.5	0.138	3.5	3.94	100.1	1.43	12	
SCF-SS30374	3	3.74	95.0	0.138	3.5	3.94	100.1	1.54	12	
SCF-SS30382	3	3.82	97.0	0.138	3.5	3.94	100.1	1.70	12	
SCF-SS30390	3	3.90	99.1	0.138	3.5	3.94	100.1	1.81	12	
SCF-SS30398	3	3.98	101.1	0.138	3.5	3.94	100.1	1.96	12	
SCF-SS30409	3	4.09	103.9	0.138	3.5	3.94	100.1	2.07	12	
SCF-SS40457	4	4.57	116.1	0.158	4.0	4.19	106.4	2.20	12	
SCF-SS40465	4	4.65	118.1	0.158	4.0	4.19	106.4	2.36	12	
SCF-SS40472	4	4.72	119.9	0.158	4.0	4.19	106.4	2.51	12	
SCF-SS40480	4	4.80	121.9	0.158	4.0	4.19	106.4	2.71	12	
SCF-SS40488	4	4.88	124.0	0.158	4.0	4.19	106.4	2.91	12	
SCF-SS40496	4	4.96	126.0	0.158	4.0	4.19	106.4	3.09	8	
SCF-SS40508	4	5.08	129.0	0.158	4.0	4.19	106.4	3.26	8	
SCF-SS40520	4	5.20	132.1	0.158	4.0	4.19	106.4	3.46	8	
SCF-SS40531	4	5.31	134.9	0.158	4.0	4.19	106.4	3.64	8	

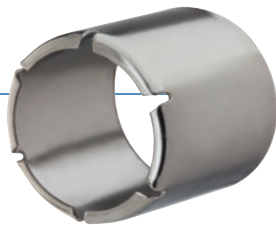

CRF-SS Series (304 Stainless Steel)
KuriCrimp™ Crimp Ferrules

FEATURES AND ADVANTAGES

- Designed for use with TCS-SS, FBS-SS, MBS-SS, FILS-SS, MILS-SS and TES-SS series fittings.

Part Number	Hose ID		Ferrule ID		Wall Thickness		Length		Weight Each (lbs)	Standard Carton
	(in)	(in)	(mm)	(in)	(mm)	(in)	(mm)			
CRF-SS10108	1	1.50	38.1	0.059	1.5	2.29	58.2	0.20	200	
CRF-SS10109	1	1.56	39.6	0.059	1.5	2.29	58.2	0.21	200	
CRF-SS10110	1	1.63	41.4	0.059	1.5	2.29	58.2	0.21	200	
CRF-SS10111	1	1.69	42.9	0.059	1.5	2.29	58.2	0.23	200	

(CONTINUED)

Because we continually examine ways to improve our products, we reserve the right to alter specifications or discontinue products without prior notice.

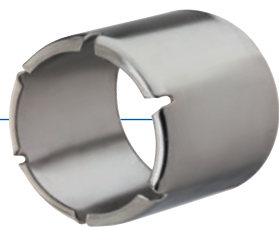

CRF-SS Series (304 Stainless Steel) KuriCrimp™ Crimp Ferrules

FEATURES AND ADVANTAGES

- Designed for use with TCS-SS, FBS-SS, MBS-SS, FILS-SS, MILS-SS and TES-SS series fittings.

VIEW ONLINE



SCAN FOR INFO

or visit

KOA.link/CRF-SS

(continued from pg. 126)

Part Number	Hose ID	Ferrule ID	Wall Thickness		Length		Weight Each (lbs)	Standard Carton	
	(in)	(in)	(in)	(mm)	(in)	(mm)			
CRF-SS10112	1	1.75	44.5	0.059	1.5	2.29	58.2	0.23	200
CRF-SS10113	1	1.81	46.0	0.059	1.5	2.29	58.2	0.24	200
CRF-SS15200	1 1/2	2.00	50.8	0.059	1.5	2.36	60.0	0.27	128
CRF-SS15202	1 1/2	2.12	53.8	0.059	1.5	2.36	60.0	0.29	128
CRF-SS15204	1 1/2	2.25	57.2	0.059	1.5	2.36	60.0	0.29	80
CRF-SS15206	1 1/2	2.39	60.7	0.059	1.5	2.36	60.0	0.30	80
CRF-SS15208	1 1/2	2.50	63.5	0.059	1.5	2.36	60.0	0.35	80
CRF-SS20209	2	2.56	65.0	0.059	1.5	2.79	70.9	0.40	80
CRF-SS20210	2	2.62	66.5	0.059	1.5	2.79	70.9	0.43	80
CRF-SS20211	2	2.68	68.1	0.059	1.5	2.79	70.9	0.43	80
CRF-SS20213	2	2.81	71.4	0.059	1.5	2.79	70.9	0.44	80
CRF-SS20215	2	2.94	74.7	0.059	1.5	2.79	70.9	0.46	80
CRF-SS25302	2 1/2	3.12	71.4	0.059	1.5	3.11	79.0	0.56	60
CRF-SS25304	2 1/2	3.25	74.7	0.059	1.5	3.11	79.0	0.58	60
CRF-SS25306	2 1/2	3.39	86.1	0.059	1.5	3.11	79.0	0.60	60
CRF-SS25308	2 1/2	3.50	88.9	0.059	1.5	3.11	79.0	0.62	60
CRF-SS30309	3	3.56	86.1	0.091	2.3	3.94	100.1	1.27	40
CRF-SS30310	3	3.62	88.9	0.091	2.3	3.94	100.1	1.29	40
CRF-SS30312	3	3.75	95.3	0.091	2.3	3.94	100.1	1.31	40
CRF-SS30313	3	3.81	96.8	0.091	2.3	3.94	100.1	1.33	40
CRF-SS30315	3	3.94	100.1	0.091	2.3	3.94	100.1	1.36	40
CRF-SS30400	3	4.00	101.6	0.091	2.3	3.94	100.1	1.40	40
CRF-SS40409	4	4.56	115.8	0.091	2.3	4.19	106.4	1.57	30
CRF-SS40410	4	4.63	117.6	0.091	2.3	4.19	106.4	1.59	30
CRF-SS40411	4	4.68	118.9	0.091	2.3	4.19	106.4	1.74	30
CRF-SS40412	4	4.75	120.7	0.091	2.3	4.19	106.4	1.76	30
CRF-SS40413	4	4.81	122.2	0.091	2.3	4.19	106.4	1.78	30
CRF-SS40414	4	4.88	124.0	0.091	2.3	4.19	106.4	1.82	30
CRF-SS40500	4	5.00	127.0	0.091	2.3	4.19	106.4	1.86	30
CRF-SS40501	4	5.06	128.5	0.091	2.3	4.19	106.4	1.89	30

Because we continually examine ways to improve our products, we reserve the right to alter specifications or discontinue products without prior notice.

SANITARY GASKETS – TRI-CLAMP

VIEW ONLINE



SCAN FOR INFO

or

visit

KOA.link/Tri-Clamp

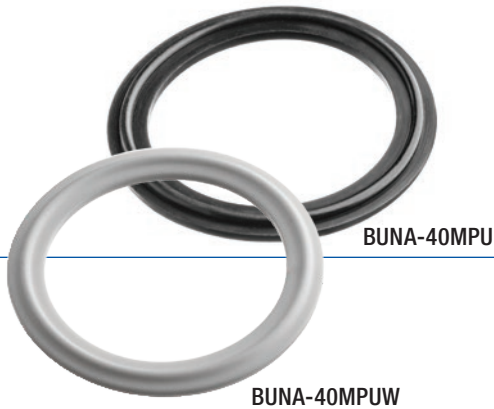

BUNA-40MPU Series

Sanitary Buna-N Tri-Clamp Gasket Black

BUNA-40MPUW Series

Sanitary Buna-N Tri-Clamp Gasket White

CERTIFICATION

3A 18-03 sanitary standard.

SERVICE TEMPERATURE RANGE

-65°F (-54°C) to +210°F (+99°C)



Part Number	Size (in)	Weight Each (lbs)	Standard Carton
BUNA-40MPU100	1	0.012	25
BUNA-40MPU150	1 1/2	0.013	25
BUNA-40MPU200	2	0.014	25
BUNA-40MPU250	2 1/2	0.018	25
BUNA-40MPU300	3	0.020	25
BUNA-40MPU400	4	0.030	25
BUNA-40MPU600	6	0.040	25
BUNA-40MPUW100	1	0.012	25
BUNA-40MPUW150	1 1/2	0.013	25
BUNA-40MPUW200	2	0.014	25
BUNA-40MPUW250	2 1/2	0.018	25
BUNA-40MPUW300	3	0.022	25
BUNA-40MPUW400	4	0.034	25

Because we continually examine ways to improve our products, we reserve the right to alter specifications or discontinue products without prior notice.

SANITARY GASKETS – TRI-CLAMP

VIEW ONLINE



SCAN FOR INFO

visit KOA.link/Tri-Clamp



EPDM-40MPE Series

Sanitary EPDM Tri-Clamp Gasket Black

CERTIFICATION

3A 18-03 sanitary standard.

SERVICE TEMPERATURE RANGE

-60°F (-51°C) to +300°F (+149°C)

COLOR CODE

3 GREEN DOTS 

Part Number	Size (in)	Weight Each (lbs)	Standard Carton
EPDM-40MPE100	1	0.012	25
EPDM-40MPE150	1 1/2	0.013	25
EPDM-40MPE200	2	0.014	25
EPDM-40MPE250	2 1/2	0.016	25
EPDM-40MPE300	3	0.020	25
EPDM-40MPE400	4	0.030	25

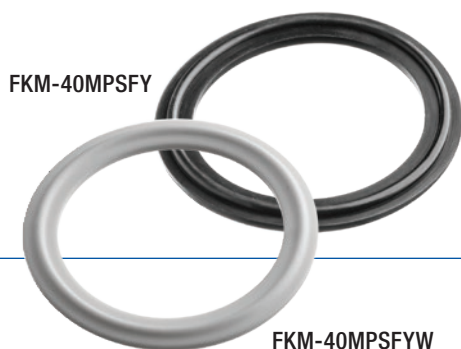

FKM-40MPSFY Series

Sanitary FKM Tri-Clamp Gasket Black

FKM-40MPSFYW Series

Sanitary FKM Tri-Clamp Gasket White

CERTIFICATION

3A 18-03 sanitary standard.

SERVICE TEMPERATURE RANGE

-20°F (-29°C) to +350°F (+177°C)

COLOR CODE

1 WHITE/1 YELLOW DOT 

Part Number	Size (in)	Weight Each (lbs)	Standard Carton
FKM-40MPSFY100	1	0.013	25
FKM-40MPSFY150	1 1/2	0.014	25
FKM-40MPSFY200	2	0.018	25
FKM-40MPSFY300	3	0.030	25
FKM-40MPSFY400	4	0.046	25
FKM-40MPSFYW100	1	0.013	25
FKM-40MPSFYW150	1 1/2	0.014	25
FKM-40MPSFYW200	2	0.018	25
FKM-40MPSFYW300	3	0.030	25
FKM-40MPSFYW400	4	0.046	25

Because we continually examine ways to improve our products, we reserve the right to alter specifications or discontinue products without prior notice.

SANITARY GASKETS – TRI-CLAMP

VIEW ONLINE



SCAN FOR INFO | or visit KOA.link/Tri-Clamp

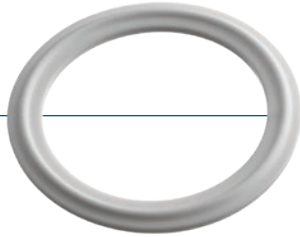

PTFE-40MPG Series
Sanitary PTFE Tri-Clamp Gasket White

CERTIFICATION
USP Class VI standard.

SERVICE TEMPERATURE RANGE
-40°F (-40°C) to +450°F (+232°C)

COLOR CODE
NONE

Part Number	Size (in)	Weight Each (lbs)	Standard Carton
PTFE-40MPG100	1	0.013	25
PTFE-40MPG150	1 1/2	0.014	25
PTFE-40MPG200	2	0.018	25
PTFE-40MPG300	3	0.028	25
PTFE-40MPG400	4	0.040	25

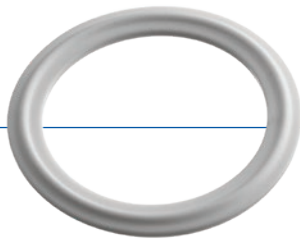

SIL-40MPX Series
Sanitary Silicone Tri-Clamp Gasket White

CERTIFICATION
3A 18-03 sanitary standard.

SERVICE TEMPERATURE RANGE
-80°F (-62°C) to +450°F (+232°C)

COLOR CODE
1 PINK DOT 

Part Number	Size (in)	Weight Each (lbs)	Standard Carton
SIL-40MPX100	1	0.012	25
SIL-40MPX150	1 1/2	0.013	25
SIL-40MPX200	2	0.014	25
SIL-40MPX300	3	0.018	25
SIL-40MPX400	4	0.030	25

Because we continually examine ways to improve our products, we reserve the right to alter specifications or discontinue products without prior notice.

SANITARY GASKETS – I-LINE

VIEW ONLINE



SCAN FOR INFO

or

visit
[KOA.link/
Gaskets_I-Line](http://KOA.link/Gaskets_I-Line)



BUNA-40IH Series

Sanitary Buna-N I-Line Gasket Black

CERTIFICATION

3A 18-03 sanitary standard.

SERVICE TEMPERATURE RANGE

-65°F (-54°C) to +210°F (+99°C)

COLOR CODE

1 RED DOT 

Part Number	Size (in)	Weight Each (lbs)	Standard Carton
BUNA-40IH150	1 1/2	0.006	25
BUNA-40IH200	2	0.007	25
BUNA-40IH300	3	0.012	25
BUNA-40IH400	4	0.016	25



FKM-40IV Series

Sanitary FKM I-Line Gasket Black

CERTIFICATION

3A 18-03 sanitary standard.

SERVICE TEMPERATURE RANGE

-20°F (-29°C) to +350°F (+177°C)

COLOR CODE

1 WHITE/1 YELLOW DOT  

Part Number	Size (in)	Weight Each (lbs)	Standard Carton
FKM-40IV150	1 1/2	0.006	25
FKM-40IV200	2	0.008	25
FKM-40IV300	3	0.014	25
FKM-40IV400	4	0.018	25

Because we continually examine ways to improve our products, we reserve the right to alter specifications or discontinue products without prior notice.

SANITARY GASKETS – BEVEL SEAT

VIEW ONLINE



SCAN FOR INFO | or visit KOA.link/Bevel



BUNA-40BSO Series
Sanitary Buna-N Bevel Seat Gasket Black

CERTIFICATION

3A 18-03 sanitary standard.

SERVICE TEMPERATURE RANGE

-65°F (-54°C) to +210°F (+99°C)

COLOR CODE

1 RED DOT 

Part Number	Size (in)	Weight Each (lbs)	Standard Carton
BUNA-40BS0100	1	0.008	25
BUNA-40BS0150	1 1/2	0.014	25
BUNA-40BS0200	2	0.018	25
BUNA-40BS0250	2 1/2	0.018	25
BUNA-40BS0300	3	0.034	25
BUNA-40BS0400	4	0.038	25

Because we continually examine ways to improve our products, we reserve the right to alter specifications or discontinue products without prior notice.

SANITARY CLAMP TYPES

SINGLE PIN

Single pin, or single hinge, clamps are available for both Tri-Clamp and I-Line fittings, and are the industry standard. They consist of two segments connected by a single pin and wing nut, allowing for easy hand tightening.

DOUBLE PIN

Double pin clamps are available for the Tri-Clamp fitting. They have an additional pin, which helps provide more evenly distributed sealing pressure.

DOUBLE BOLT

Double bolts are also available for the Tri-Clamp fittings. They're a heavier duty construction, connected by tightening two bolts. They're popular in more permanent applications and have higher pressure ratings than the single and double pin clamps.

SANITARY CLAMP TORQUE AND PRESSURE RATINGS

Part Number	Pressure Rating (psi)*		Torque Rating (In/lbs)
	at +70°F (+21°C)	at +250°F (+121°C)	
SPHDS150	500	250	25
SPHDS200	450	250	25
SPHDS250	400	200	25
SPHDS300	350	150	25
SPHDS400	200	125	25
SPHDS600	150	75	25
DPHDS150	500	250	25
DPHDS200	450	250	25
DPHDS250	400	200	25
DPHDS300	350	150	25
DPHDS400	200	125	25
DBS150	1500	1200	30
DBS200	1000	800	30
DBS300	1000	800	30
DBS400	800	800	30
SPILC150	500	250	25
SPILC200	450	250	25
SPILC300	350	150	25
SPILC400	200	125	25

*Note: Pressure ratings shown represent those of the clamp alone and are generally higher than those of a full union, including a gasket, which will fail before the clamp.

Because we continually examine ways to improve our products, we reserve the right to alter specifications or discontinue products without prior notice.

SIZING GUIDE FOR TRI-CLAMP FITTINGS & GASKETS

Place the face of the tri-clamp over the following, actual-size drawings, to determine the size of the fitting or corresponding clamp needed. Note: the clamp and fitting sizes are determined by the ID of the hose, not the ID or OD of the tri-clamp.

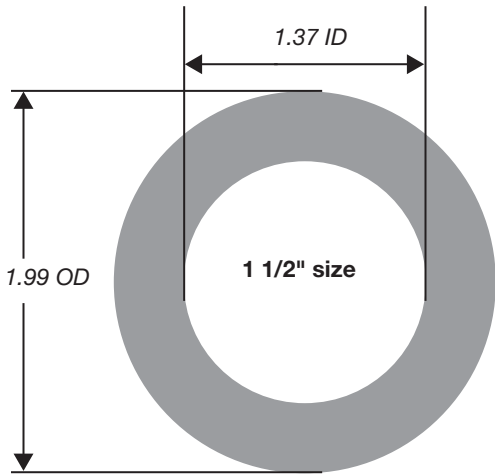
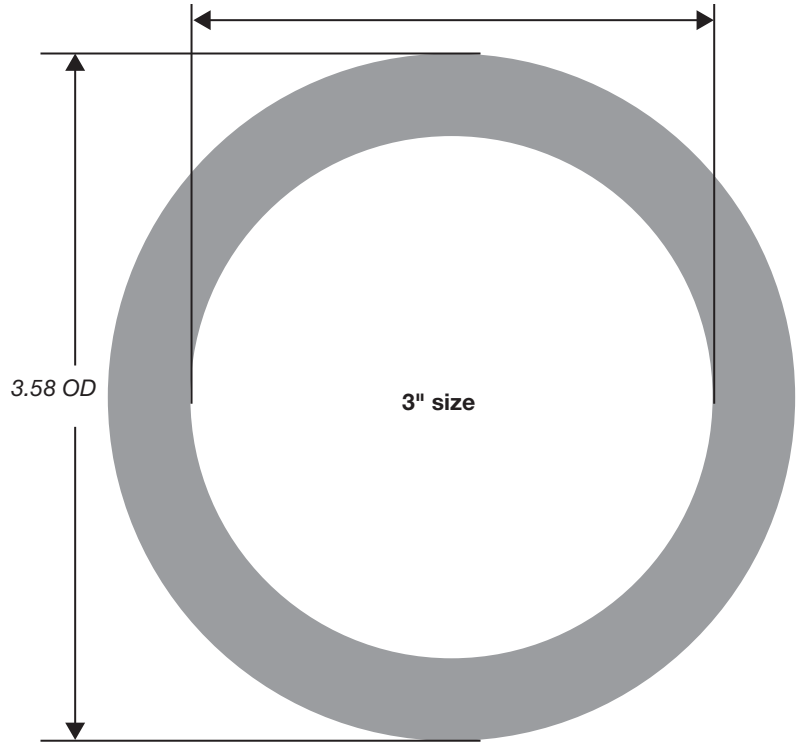
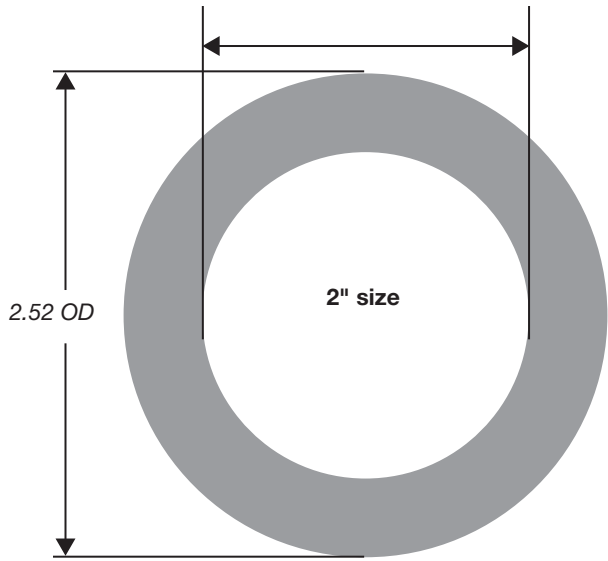

Note: Both 1" & 1 1/2" tri-clamps use the 1 1/2" size clamp.

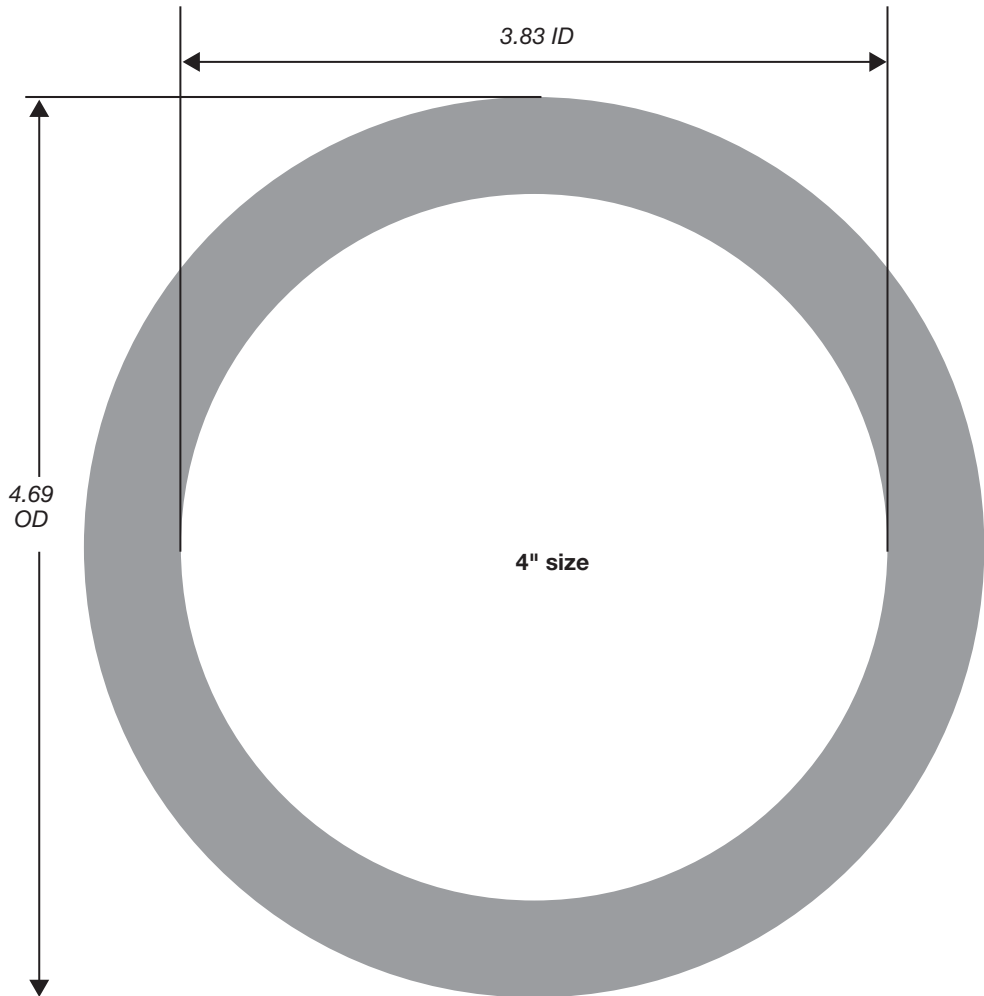
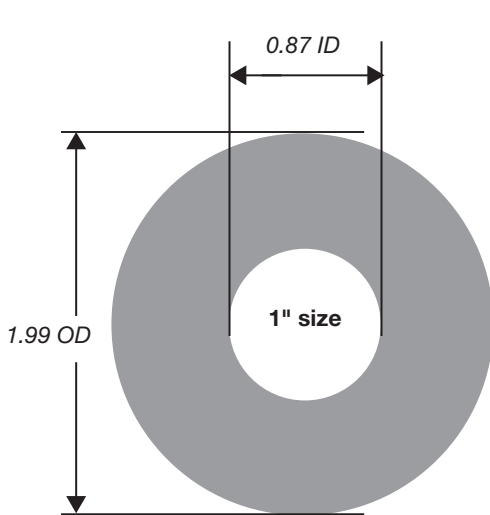



SANITARY GASKET TYPES

Sanitary gaskets are available in a variety of materials, each possessing unique performance characteristics, and should be selected based on the specific demands of the application in which they will be used. Please refer to the following sanitary gasket elastomer characteristics to assist with proper gasket selection.

Buna (Nitrile) gaskets are the most popular and economic, and are common in food and beverage applications. They have good resistance to oils and animal fats, and good resistance to moderately aggressive chemicals.

EPDM gaskets are also very popular, economic gaskets, and are common in food and beverage, pharmaceutical and cosmetic/personal care applications. They exhibit higher chemical and heat resistance than Buna, but are acceptable for steam only intermittently and at lower pressures. They can experience swelling and deformation when exposed to certain oils and animal fats.

FKM (Viton®) gaskets exhibit good all-around characteristics, with good oil, alcohol and acid resistance, and a slightly higher heat and steam tolerance than EPDM.

PTFE (Teflon®) gaskets exhibit exceptional chemical resistance, and extremely high tolerances to heat and steam. However, they're a plastic as opposed to an elastomer, and therefore not as compressible as other gasket materials, which can lead to difficulty in sealing if misaligned. They can experience cold flow, especially if clamps are misaligned or overtightened, resulting in a reduction in sealing pressure.

Silicone gaskets exhibit the widest temperature range. They're often used in place of PTFE gaskets in fluid or steam applications when greater compressibility and leak resistance is required.

ELASTOMER CHARACTERISTICS

Characteristic	Buna-N (Nitrile)	EPDM	FKM (Viton®)	PTFE (Teflon®)	Silicone
Identification Dot Code	1 red	3 green	1 white and 1 yellow	None	1 pink
Industry Designation	U	E	SFY	G	X
Temperature Range	-65°F (-54°C) to +210°F (+99°C)	-60°F (-51°C) to +300°F (+149°C)	-20°F (-29°C) to +350°F (+177°C)	-40°F (-40°C) to +450°F (+232°C)*	-80°F (-62°C) to +450°F (+232°C)
Fats & Oils Resistance	Good to Excellent	Poor	Good to Excellent	Excellent	Fair
Acid Resistance	Good	Good to Excellent	Good to Excellent	Good to Excellent	Fair
Alkali Resistance	Good	Good to Excellent	Fair	Excellent	Poor to Fair
Abrasion Resistance	Excellent	Good	Good	Fair	Good
Compression Set Resistance	Good	Fair	Good to Excellent	Cold Flows*	Good to Excellent
FDA CFR 21 Compliant	Yes	Yes	Yes	Yes	Yes
Certification	3A	3A	3A	USP Class VI	3A

*PTFE can experience cold flow over time, especially when subjected to temperature fluctuations, resulting in reduction of sealing pressure.

Note: the performance of sanitary gaskets depends on many factors that are governed by the application. This chart cannot be construed as an approval of the gasket for any particular purpose, use, or application.

Note: Viton® and Teflon® are registered trademarks of The Chemours Company FC, LLC.

Because we continually examine ways to improve our products, we reserve the right to alter specifications or discontinue products without prior notice.



GASKET IDENTIFICATION

The particular type of gasket material can be identified by the dot pattern printed on the side of each gasket.

Material	Identification Dot Code	Example
Buna-N (Nitrile)	1 red dot	●
EPDM	3 green dots	● ● ●
FKM (Viton®)	1 white and 1 yellow dot	○ ●
PTFE (Teflon®)	None	
Silicone	1 pink dot	●

Because we continually examine ways to improve our products, we reserve the right to alter specifications or discontinue products without prior notice.



HOSE BUMPERS

Hose bumpers are installed near the hose ends to help protect the fittings from damage if the hose is accidentally dropped, and to keep the hose ends clean by elevating them off the floor. Each bumper is made from chemical and heat resistant, shock absorbing silicone. The bumpers slide easily and securely over the end of the ferrule after crimping.



HOSE RISERS

Hose risers elevate the hose off the floor, helping it slide easily when being moved from place to place, keeping it clean and protecting the outside from damage. They also allow for better floor drainage by preventing damming and pooling of liquids near the hose during wash down. The risers are made from durable, chemical resistant polyethylene, and are easily attached throughout the hose with two stainless steel screws.

Because we continually examine ways to improve our products, we reserve the right to alter specifications or discontinue products without prior notice.